

## 六爪顶装布水器 (top mount 6 laterals)

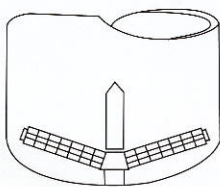

注: IPSI=0.007Mpa, 1GPM=227L/H

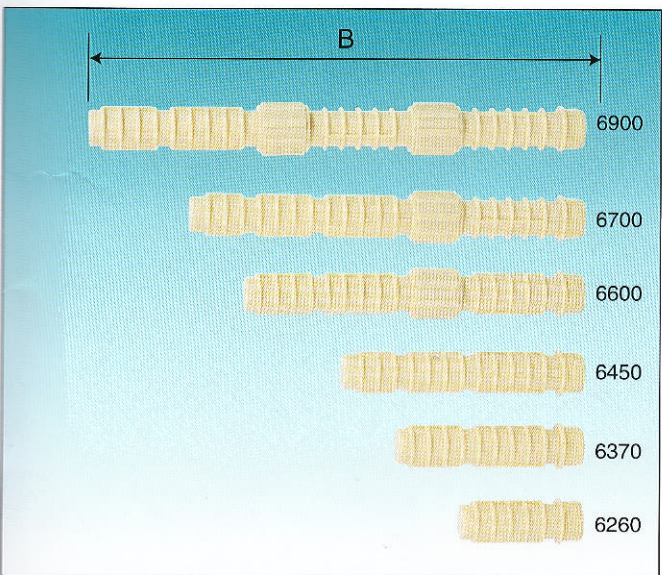
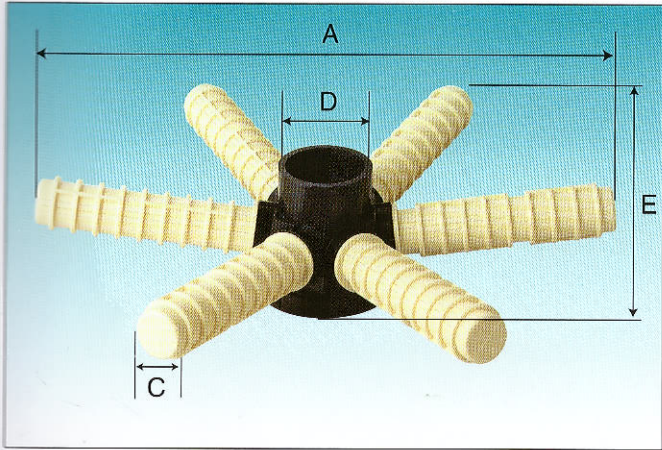
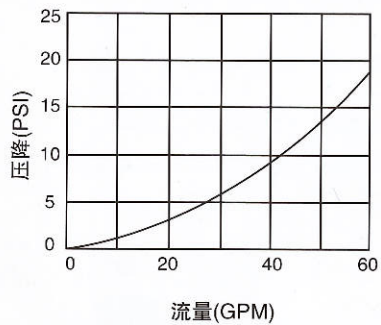

HU6260  
(JD301)

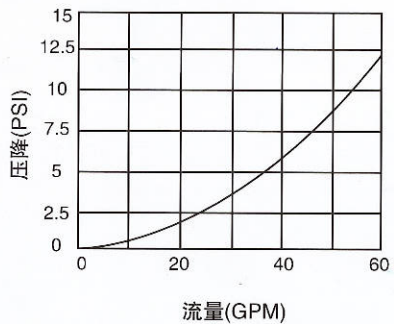

HU6370  
(JD302)

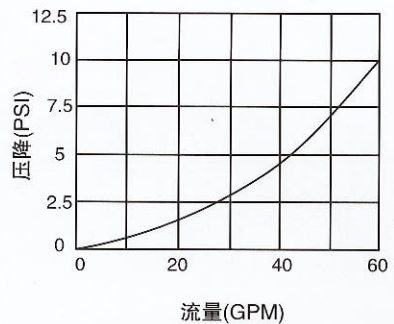

HU6450  
(JD303)

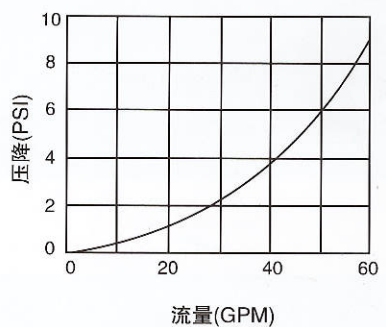

HU6600/HU6700  
(JD304/JD305)

订货号 (Serial No.)	型号 (Item No.)	Dimensions(mm)					适用罐体 Diameter (inches/mm)	罐体上口开 (Top opening)
		A	B	C	D	E		
JD301	HU6260	253	98	35	48.5/50/42	85	12"~16"(ø300-ø400mm)	4"~8"THREAD
JD302	HU6370	350	153	35	48.5/50/42	100	18"~21"(ø450-ø550mm)	4"~8"THREAD
JD303	HU6450	445	200	35	48.5/50/42	110	24"(ø600mm)	4"~8"THREAD
JD304	HU6600	590	281	35	48.5/50/42	132	30"(ø750mm)	4"~8"THREAD
JD305	HU6700	680	327	35	48.5/50/42	145	36"(ø900mm)	4"~8"THREAD
JD330	HU6900	835	406	35	48.5/50/42	165	40"(ø1000mm)	4"~8"THREAD



## (高流速)六爪顶装布水器 (high flow top mount 6 laterals)

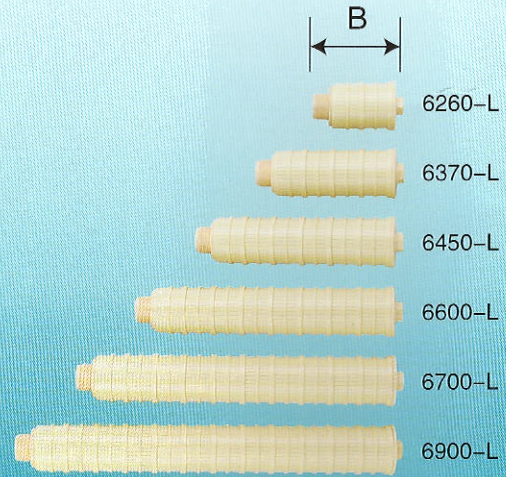
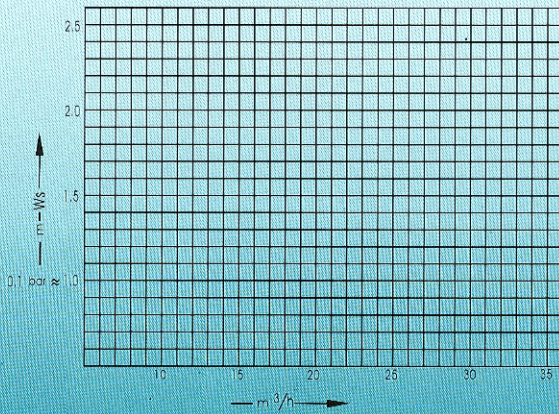
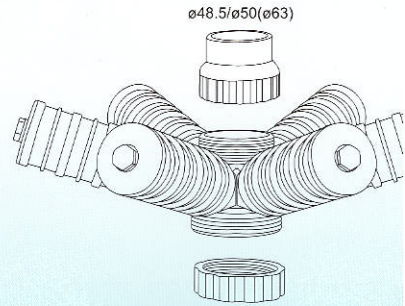
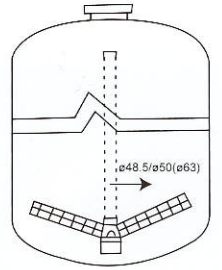
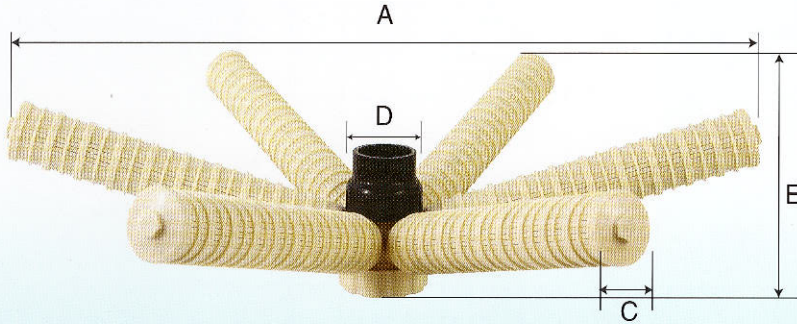

订货号 (Serial No.)	型号 (Item No.)	Dimensions(mm)					支管缝隙 slot size	适用罐体 Diameter (inches/mm)	罐体上口开 (Top opening)
		A	B	C	D	E			
JD324	HU6260-L	235	99	53	48.5/50	95	0.2/0.25/0.4mm	13~16"(ø350~ø400)	4"~8"THREAD
JD306	HU6370-L	350	161	53	48.5/50	115	0.2/0.25/0.4mm	18~20"(ø450~ø500)	4"~8"THREAD
JD307	HU6450-L	465	223	53	48.5/50	130	0.2/0.25/0.4mm	24"(ø600)	4"~8"THREAD
JD308	HU6600-L	585	283	53	48.5/50/63	145	0.2/0.25/0.4mm	30"(ø750)	4"~8"THREAD
JD309	HU6700-L	705	348	53	48.5/50/63	160	0.2/0.25/0.4mm	36~40"(ø900~ø1000)	4"~8"THREAD
JD310	HU6900-L	825	410	53	48.5/50/63	180	0.2/0.25/0.4mm	48"(ø1200)	4"~8"THREAD



## 十二爪顶装双层布水器 (top mount 12 laterals)

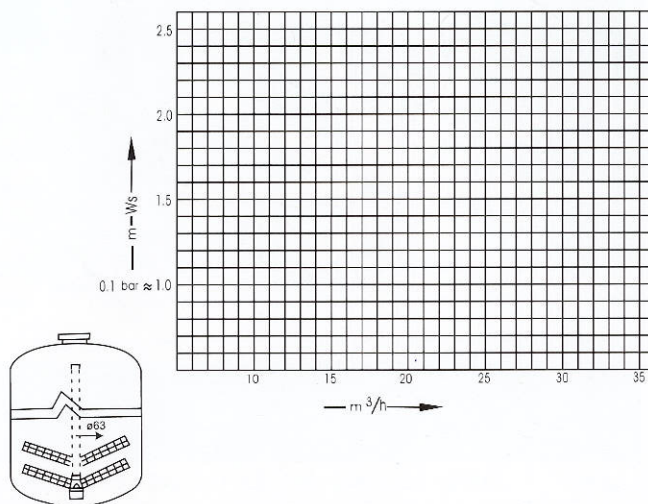
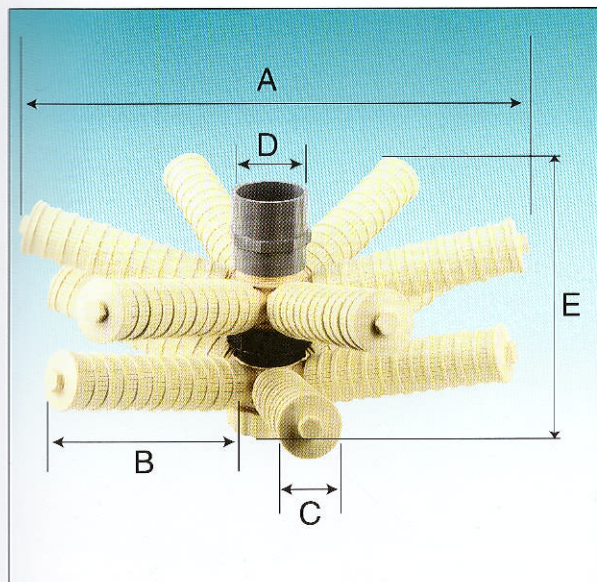

订货号 (Serial No.)	型号 (Item No.)	Dimensions(mm)					支管缝隙 slot size	适用罐体 Diameter (inches/mm)	罐体上口开 (Top opening)
		A	B	C	D	E			
JD326	HU6700-2L	705	348	53	63	245	0.2/0.25/0.4mm	36~40"(ø900~ø1000)	4"~8"THREAD
JD327	HU6900-2L	825	416	53	63	258	0.2/0.25/0.4mm	48~60"(ø1200~ø1500)	4"~8"THREAD

## 6"法兰富来克3900上布水(top distributor for Fleck 3900)

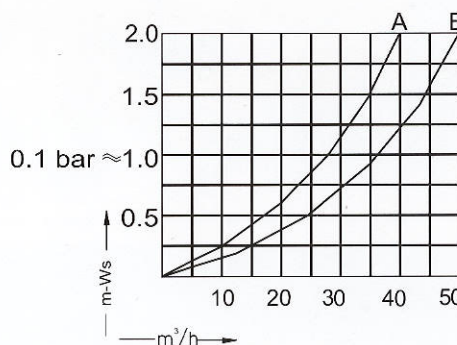
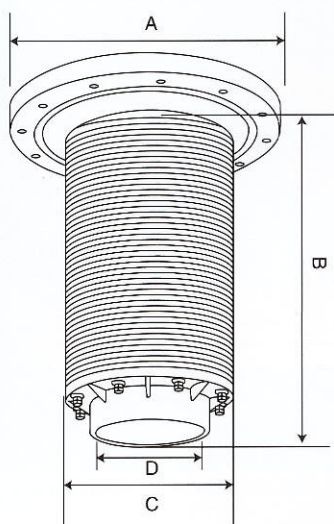

订货号 (Serial No.)	型号 (Item No.)	Dimensions(mm)					支管缝隙 slot size	适用罐体 Diameter (inches/mm)	罐体上口开 (Top opening)
		A	B	C	D				
JD436	SS-10-300F	240	325	140	90	0.25/0.4mm	36"~60"(ø900~ø1500mm)	6"FLG	
JD437	SS-10-400F	240	425	140	90	0.25/0.4mm	60"~80"(ø1500~ø2000mm)	6"FLG	



## 十六爪侧装布水器 (bottom mount 8 laterals, 6" flange)

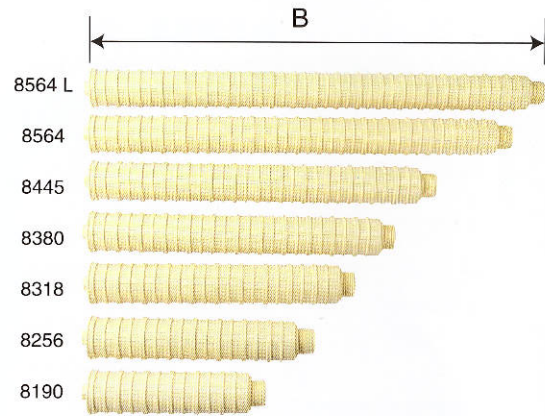
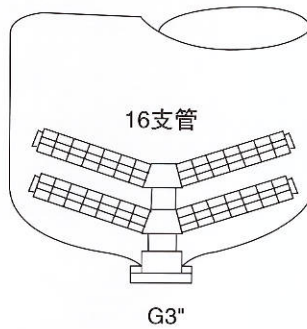
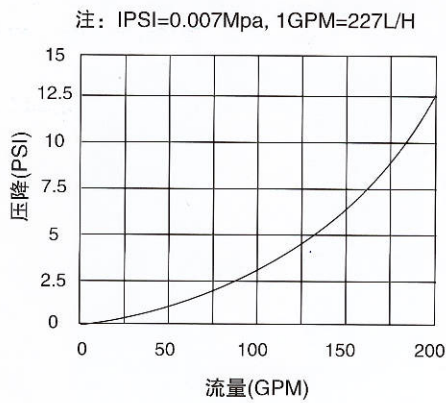
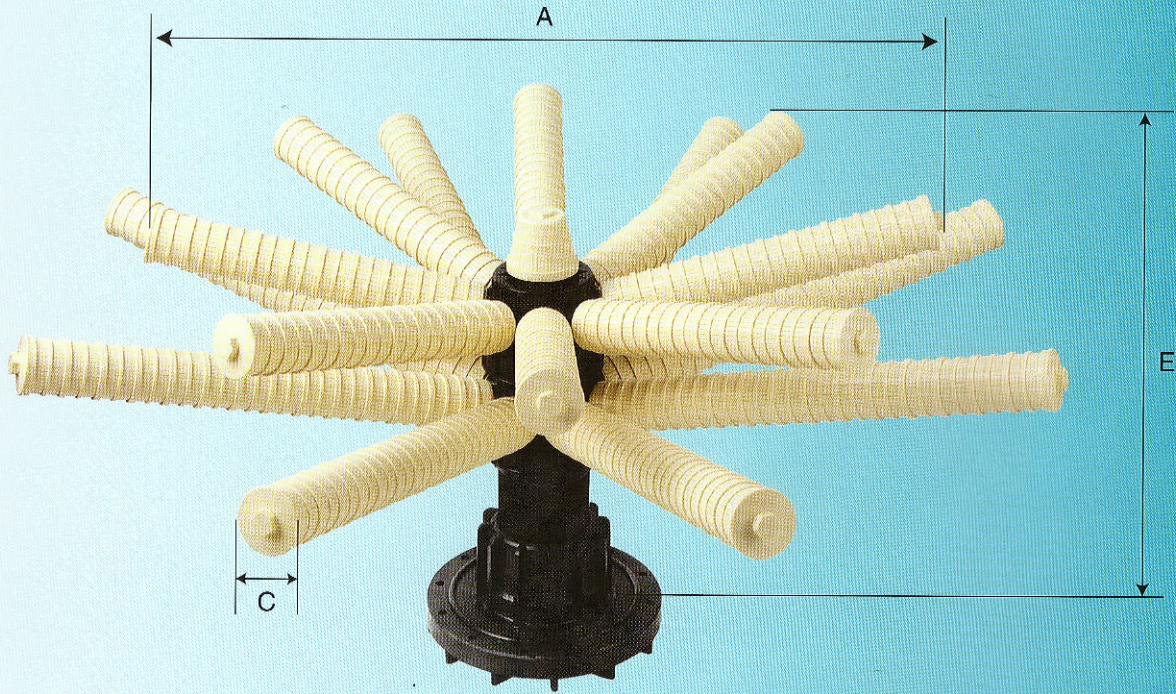

订货号 (Serial No.)	型号 (Item No.)	Dimensions(mm)					支管缝隙 slot size	适用罐体 Diameter (inches/mm)	罐体下口开 (bottom opening)
		A	B	C	E				
JD425	JD8190-2X	510	228	53	461	0.2/0.25mm	24"(ø600mm)	6"FLG	
JD426	JD8256-2X	630	290	53	476	0.2/0.25mm	30"(ø750mm)	6"FLG	
JD427	JD8318-2X	750	350	53	491	0.2/0.25mm	36"(ø900mm)	6"FLG	
JD428	JD8380-2X	870	412	53	505	0.2/0.25mm	40"(ø1000mm)	6"FLG	
JD429	JD8445-2X	985	475	53	526	0.2/0.25mm	48"(ø1200mm)	6"FLG	
JD430	JD8564-2X	1225	600	53	551	0.2/0.25mm	56"~65"(ø1400~ø1600mm)	6"FLG	
JD431	JD8564-2XL	1345	660	53	566	0.2/0.25mm	65"~80"(ø1600~ø2000mm)	6"FLG	



# 八爪过滤型侧装下布水器 (bottom mount 8 laterals 6" flange filter model)

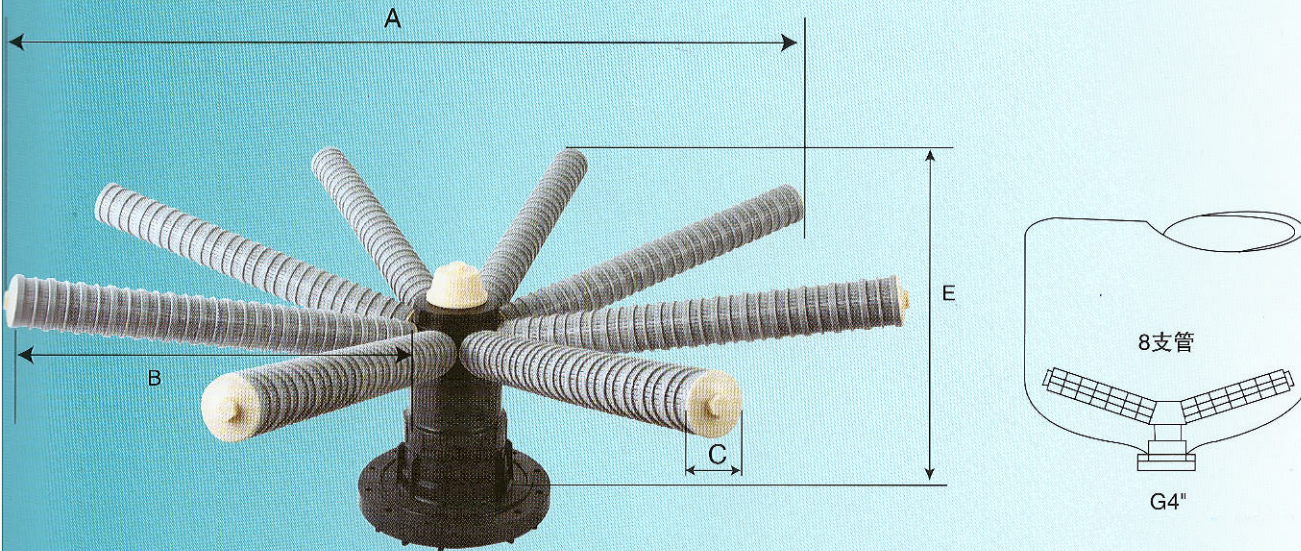

注: IPSI=0.007Mpa, 1GPM=227L/H

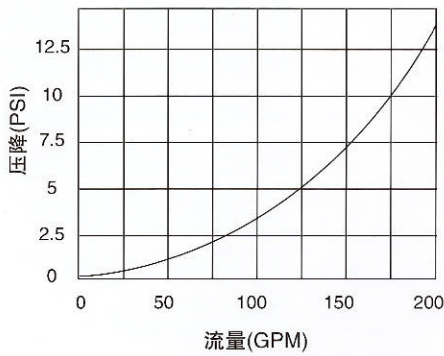

JD8190-1XF JD8256-1XF JD8318-1XF JD8380-1XF

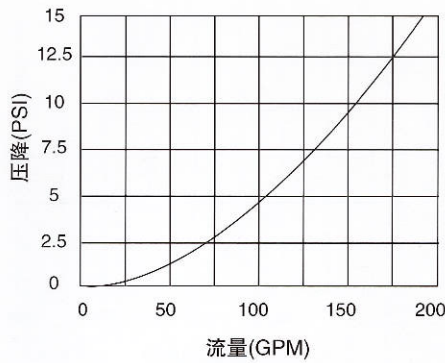

JD8445-1XF JD8564-1XF JD8564-1XLF

订货号 (Serial No.)	型号 (Item No.)	Dimensions(mm)					支管缝隙 slot size	适用罐体 Diameter (inches/mm)	罐体下口开 (bottom opening)
		A	B	C	E				
JD418F	JD8190-1XF	510	228	53	222	0.5mm	24"(ø600mm)	6"FLG	
JD419F	JD8256-1XF	630	290	53	237	0.5mm	30"(ø750mm)	6"FLG	
JD420F	JD8318-1XF	750	350	53	252	0.5mm	36"(ø900mm)	6"FLG	
JD421F	JD8380-1XF	870	412	53	272	0.5mm	40"(ø1000mm)	6"FLG	
JD422F	JD8445-1XF	985	475	53	287	0.5mm	48"(ø1200mm)	6"FLG	
JD423F	JD8564-1XF	1225	600	53	312	0.5mm	56"~65"(ø1400~ø1600mm)	6"FLG	
JD424F	JD8564-1XLF	1345	660	53	327	0.5mm	65"~80"(ø1600~ø2000mm)	6"FLG	



## 十六爪过滤型侧装下布水器 (bottom mount 8 laterals, 6" flange filter model)

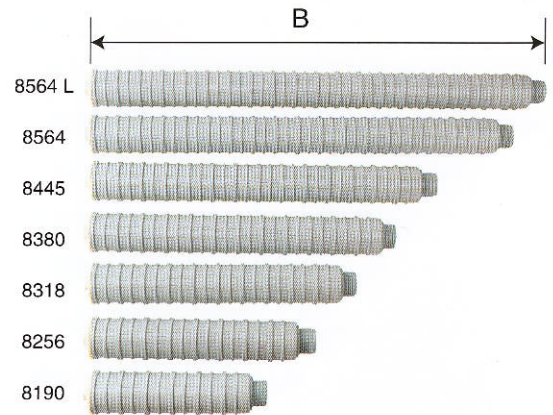
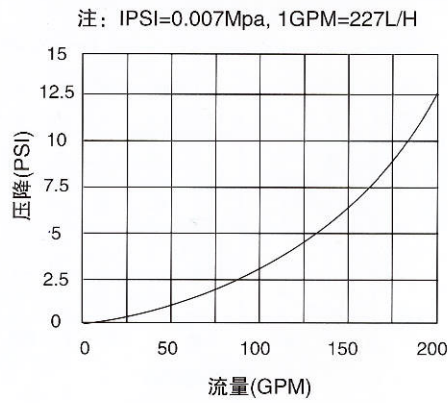
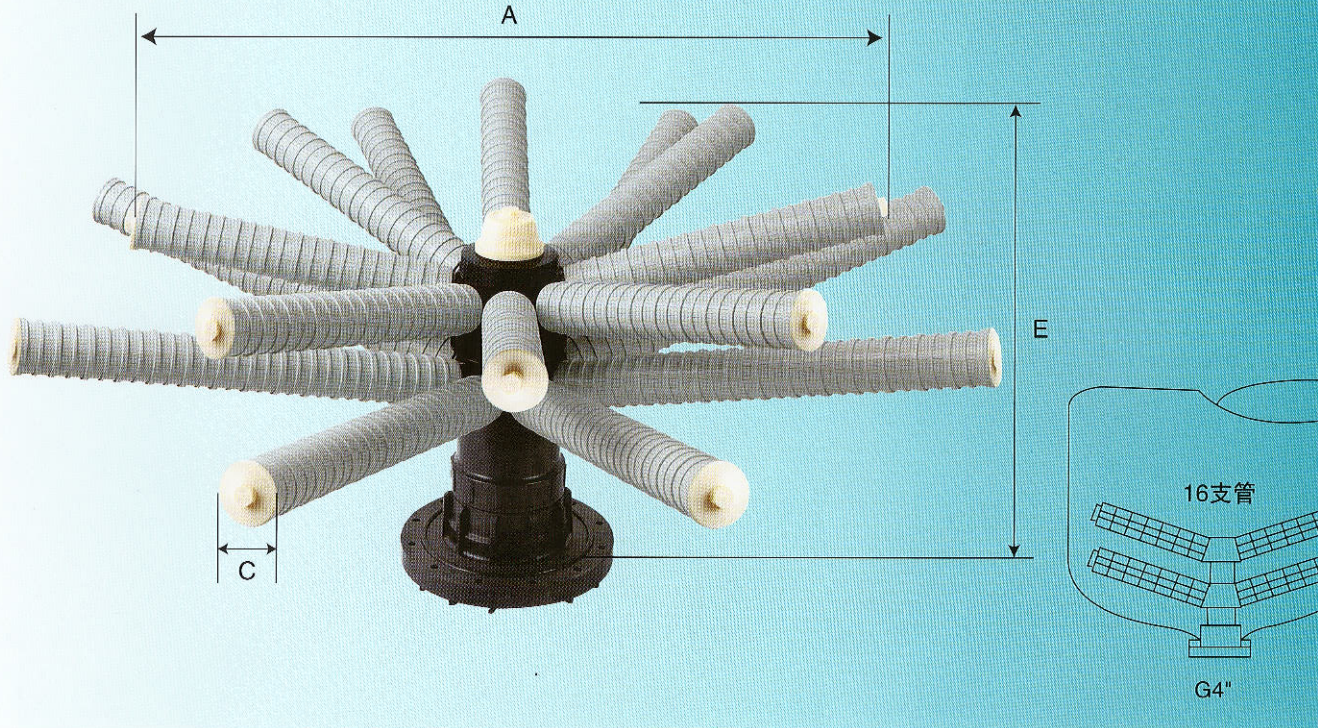

订货号 (Serial No.)	型号 (Item No.)	Dimensions(mm)					支管缝隙 slot size	适用罐体 Diameter (inches/mm)	罐体下口开 (bottom opening)
		A	B	C	E				
JD425F	JD8190-2XF	510	228	53	314	0.5mm	24"(ø600mm)	6"FLG	
JD426F	JD8256-2XF	630	290	53	329	0.5mm	30"(ø750mm)	6"FLG	
JD427F	JD8318-2XF	750	350	53	344	0.5mm	36"(ø900mm)	6"FLG	
JD428F	JD8380-2XF	870	412	53	364	0.5mm	40"(ø1000mm)	6"FLG	
JD429F	JD8445-2XF	985	475	53	379	0.5mm	48"(ø1200mm)	6"FLG	
JD430F	JD8564-2XF	1225	600	53	404	0.5mm	56"~65"(ø1400~ø1600mm)	6"FLG	
JD431F	JD8564-2XLF	1345	660	53	419	0.5mm	65"~80"(ø1600~ø2000mm)	6"FLG	